



QUICK USER'S GUIDE

RESIDENTIAL SERIES ● recuperators



Use the QR code or visit the website: prana.help/b22 to view information about the device, user manual and other useful information.

- The quick user's guide contains only the most necessary information, thus we contribute to the protection of the environment.
- Some content may differ from your device depending on the model, region or software version, and may change without prior notice.
- In order to use the device safely and properly, first read all the information concerning safety measures carefully.

MODEL RANGE: PRANA 2022 ®

CONTENT

WARNINGS AND SAFETY MEASURES	4
DEVICE AND SOFTWARE UPDATE	6
SYSTEM CONFIGURATION	7
DESCRIPTION OF THE REMOTE CONTROL	8
DESCRIPTION OF THE SYSTEM DISPLAY	9
MOBILE APPLICATION	11
DESCRIPTION OF MOBILE APP TABS	13
RECUPERATOR SELECTION	14
REGULATION OF SYSTEMS	15
CONTROL	16
PASSIVE OPERATION MODE	18
DEFROST FUNCTION	18
MANUAL CONTROL MODE	18
SEPARATE CONTROL MODE	19
NIGHT MODE	19
VENTILATION MODE	19
ADJUSTMENT OF THE INDICATION BRIGHTNESS	19
DATE AND TIME FUNCTION	20
SLEEP TIMER FUNCTION	20
AUTO AND AUTO+ MODES	21
MINI-HEATING FUNCTION	22
WINTER MODE FUNCTION	23
INDICATORS FROM SENSORS	24
EFFICIENCY INDICATOR FUNCTION	26
FILTER STATE DETERMINATION FUNCTION	27
PROGRAMMABLE CONTROL	28
PROGRAMMABLE CONTROL FUNCTION	29
STATISTICS AND GRAPHICS OF INDICATORS	31
ACCOUNT	32
REMOTE CONTROL FAILURE	34
BATTERIES REPLACEMENT OF THE RC	36
CLEANING THE REMOTE CONTROL CONTACTS	37
SYSTEM FAILURE	38
SYSTEM MAINTENANCE	40

WARNINGS AND SAFETY MEASURES

- This device may be used by children from the age of 8 years, as well as by physically or sensory disabled or mentally challenged persons or people with lack of experience and knowledge, provided that they are supervised or instructed about the safe operation of the device and understand the dangers involved. Do not allow children to play with the device. Maintenance should not be performed by children.

- During the operation of the device, the fan rotates inside it. Avoid getting foreign objects inside the device during operation. This may result in injury.

- A user without proper qualifications must not install, move, disassemble, modify or repair the recuperator themselves.

- Do not block the supply and exhaust channels, as this will reduce the quality indicators of the recuperator and may lead to system failure.

- Do not place heating equipment in the way of the air intake by appliance. Products of incomplete combustion can lead to accident.

- If the outdoor air temperature is +20°C and above, do not switch on the functions of «Mini heating», «Winter mode», «Defrost».

- Do not use the device at a temperature of +50 °C and above, near open flames, in places exposed to smoke or where it may come into contact with organic solvents. This may cause a fire.

- Make sure that the outdoor air intake is located so that smoke or other harmful gases do not enter it. If the intake air is polluted, the quantitative and qualitative indicator of oxygen in the room may decrease.

- Before use it is necessary to make sure that the mechanical and electric installation norms applied in the country where the installation is performed are observed.

- In the event of damage to the recuperator, immediately switch off the system with the circuit breaker or unplug it. Continued use of the

recuperator may result in smoke, fire, electric shock or injury. For repairs, contact the service center of the manufacturer or dealer in your area.

- We recommend that you use original PRANA filters for the recuperator to work properly and to prevent damage to the ventilation system.

- Before switching on it is necessary to open an air intake, accordingly, after use to close it (if there is no need to use a passive mode of operation).

When using the system with the air intake closed, it can damage the recuperator.

- In order to avoid icing and ensure the correct operation of the system at ambient temperatures below + 4 °C, the use of functions «Winter mode» and «Miniheating» is mandatory.

- In case of plugging in with the power plug, do not pull on the cord while trying to unplug it. The power plug must be firmly plugged into the outlet. Otherwise, it may result in electric shock.

- Avoid hitting and damage to the system (recuperator).

- Do not twist, damage, or modify the power supply cord. Do not expose it to heat or place heavy objects on it. These actions may result in fire or electric shock.

- If the power cord is damaged, in order to avoid danger it must be replaced in a service center, by a manufacturer or a qualified person.

- Sensors installed in PRANA ventilation systems are not a metrologically accurate means of measurement. The sensors are designed to monitor changes in air quality and temperature conditions for proper control of the system in automatic modes.

- The appliance must be de-energized before carrying out any operations of maintenance service (unplug the appliance or turn off the main power switch and wait for the fans to come to a complete stop).

- To prevent back draft in rooms where fireplaces, gasfired water heaters and other equipment that creates or uses different mixtures of gases operate, the use of «Separate control» mode is not allowed.

Some content may differ from your device depending on the model, region or software version, and may change without prior notice.

The PRANA recuperator is a device that is controlled from a smartphone, so some functions, performance and efficiency may change.

Some points in this guide may not be relevant if you update the software.

You can always read the updated instructions at the link:

(prana.help/b22).

You can also ask for help from the seller at the contacts listed in the warranty card (warranty card is in the technical passport of the product).

PRANA is not responsible if the client has not been able to use the «PRANA ONLINE» services on their devices and/or uses them incorrectly.

This is due to the large number of manufacturers of multimedia devices for which the adaptation of services may be performed after some time.

SYSTEM CONFIGURATION

The availability of certain functions and capabilities depends on the configuration of your recuperator.

PARAMETER	STANDARD	ERP	ERP PRO
Determining the filter condition	-	+	+
Atmospheric pressure sensor	-	+	+
Date and time	+	+	+
Temperature sensor 1	-	+	+
Temperature sensor 2	-	+	+
Temperature sensor 3	-	+	+
Temperature sensor 4	-	-	+
TVOC air quality sensor	-	-	+
Sensor (equivalent) CO ² eq	-	-	+
Relative humidity sensor	-	+	+
AUTO and AUTO + operation modes	-	+	+
Efficiency indicator	-	-	+
Bluetooth support	+	+	+
Wi-Fi support	+	+	+

DESCRIPTION OF THE REMOTE CONTROL

The appearance of the remote control is shown graphically below.

Assignment of remote control buttons.



- 1 - Adjust the display brightness
- 2 - Turn off
- 3 - Exhaust air flow control
- 4 - Reducing the speed
- 5 - Increasing the speed
- 6 - Simultaneous flow control
- 7 - Supply air flow control
- 8 - Night mode
- 9 - Ventilation mode
- 10 - On/Off «Mini-heating»
- 11 - Control of «AUTO» and «AUTO+» modes
- 12 - «Winter mode» function
- 13 - Scroll the additional menu on the left
- 14 - Scroll the additional menu on the right
- 15 - OFF/ reduce the time «Sleep Timer»
- 16 - ON/ increase in time «Sleep Timer»



The operation of the buttons may differ and depends on the system configuration; the details are described in this manual for each function or mode.

DESCRIPTION OF THE SYSTEM DISPLAY

The appearance of the system display is shown graphically below.

The indication on the display may differ depending on the system configuration; details are described in this manual.



Information is displayed on the recuperator display (additional menu) using the buttons (scroll on the left, scroll on the right)   .

The menu is cyclic and allows displaying information on the recuperator screen, such as values from certain recuperator sensors, date and time.

You can scroll through the additional menu using the remote control or mobile application.

Values from the recuperator display panel:



- Exhaust air temperature, °C



- Supply air temperature, °C



- Level of carbon dioxide equivalent, CO²eq



- Air quality indicator, TVOC



- Relative humidity, Rh%



- Efficiency indicator



- Atmospheric pressure, mm Hg



- Information panel



- «Mini-heating» function indicator



- «Winter mode» indicator



- «AUTO» and «AUTO+» function indicator



- Sleep timer indicator



- Error indicator

FLTCH - This value on the recuperator information panel indicates that the filter is dirty.

Switch on the PRANA ventilation system.

Download the PRANA Online app using Google Play (Android) or the App Store (iOS).

Or use QR codes below:



Launch the mobile app.

The Bluetooth and GPS (geolocation) functions in your device can be activated automatically. If this does not happen, turn them on yourself and restart the application.

Without this permission, our application cannot enable search.

In the bottom list after search, all PRANA ventilation systems will be placed under the following conditions:

- They are turned on
- They have a built-in Bluetooth module
- They are within range of its network

Select your device from the list, its default name is PRANA Recuperator, and password is 0000.

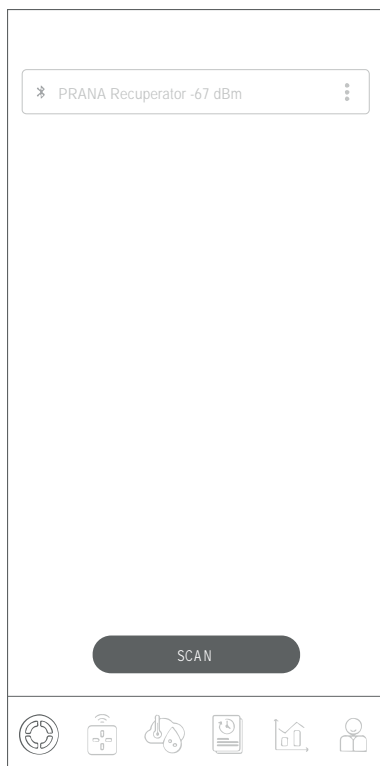

Select the Bluetooth connection method (for the initial connection), and click the «Connect» button.

After that, you can control the PRANA system (recuperator).

DESCRIPTION OF MOBILE APP TABS

A description of the tabs of the mobile application «PRANA ONLINE» as part of the ecosystem (service) is shown below.



Picture of the Tabs Menu of the PRANA ONLINE mobile app.



- Recuperator selection



- Control



- Indicators from sensors



- Programmable control



- Statistics



- Account

RECUPERATOR SELECTION

The content of the tab is graphically shown below.

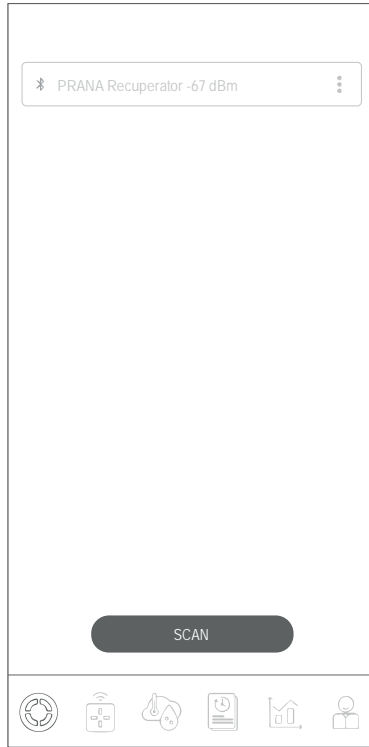

The tab allows you to select a system to control, give a name, change the name, change the password, set the connection method, connect to the storage and delete the device.

For ease of control (if there are 2 or more systems), you can assign each system an individual name and access password.

All the following steps are performed on the tab «Recuperator selection».

In order to rename the system, click  to the system to which you are currently connected and select «Rename»; use the keyboard to enter the desired system name and press «SAVE». The system will reload and accept the changes.

In order to change the system password, click  to the system to which you are currently connected and select «Change password»; use the keyboard to enter the desired password (four digits) and press «SAVE».

The system will reload and accept the changes.

SCAN button allows you to update the list of available systems on the network by searching via Bluetooth.

Later in the list of available systems you will see individual names of your systems and will control them.

Be sure to write down the password so you don't lose an access to the system and statistics.

In case you have not written it down or lost the password to the system, you can restore it to the factory settings using the combination on the remote control (when resetting the password to the factory value, statistics may be lost):

2x  2x  2x  2x 

If everything is entered correctly, RESET will appear on the system display.

Parameters that will take the original state:

- The name of the system will take the factory value: PRANA Recuperator;
- The system password will take the factory value: 0000;
- The performance statistics and the programmable control list can be deleted.

If you are interested in connecting via an Internet connection (Wi-Fi module), refer to the «Account» section.

The content of the tab is graphically shown below.

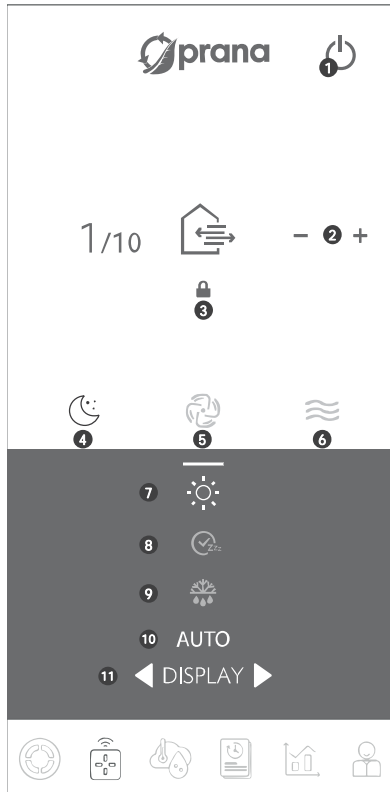

The tab allows you to control the selected system, change engine speeds, set operation modes and use functions from the mobile application.

Assignment of the buttons of the «Control» tab.

1 – Turn off

2 - Manual control of air flows

3 - Separate control of air flows

4 - Night mode

5 - «Ventilation» mode

6 - «Mini-heating» function

7 - Display brightness adjustment

8 - «Sleep Timer» Function

9 - «Winter mode» function

10 - Control of «AUTO» and «AUTO+» modes

11 - Control of the additional menu

The operation of the buttons may differ and depends on the system configuration, the details of which are described in this manual for each function or mode.

Air flows can be controlled separately from the mobile application; more details about this mode of operation are described in the «Separate control mode» section.

PASSIVE OPERATION MODE

Passive mode is the operation of the recuperator with the cover open and the engines off.

It is based on the movement of uncontrolled air flows through the recuperator. This is due to the difference in pressure and temperature inside and outside of the room.

Allowed for use when the difference between outdoor and indoor temperatures is not more than 5°C.

DEFROST FUNCTION

In the cold period, with improper operation of the recuperator there is a risk of icing of the heat exchanger, which leads to a significant efficiency reductions, accumulation of condensate in the system and icing of the engines.

In the event of icing it is necessary:

1. Turn on the recuperator;
2. Turn off the supply and exhaust;
3. Close the front cover;
4. Enable the «Mini-heating» function;
5. Wait 60 minutes for it to defrost.

Then switch on the recuperator in the required operating mode.

If there are no improvements, this algorithm must be repeated.

MANUAL CONTROL MODE

Manual mode is used as the default system mode. System performance changes in increments of 10%.



Switching speed modes can be done with +/- buttons on the remote control or in the mobile application.

You can switch the system for simultaneous flow control by pressing 2x  on the remote control or  in the mobile application.

SEPARATE CONTROL MODE

The function allows you to separately control the flow of supply and exhaust air.

Volumes of supply and exhaust air can be seen in the mobile application and info panel (values from 1 to 10).



In order to control the air flow with the remote control, press the  button for the supply or the  button for the exhaust, and then set the required volume of air with +/- buttons.

In order to control the air flow from the mobile application, press the  button and then set the required supply and exhaust volume using +/- buttons, the supply values will be at the top and the exhaust values at the bottom.

NIGHT MODE



«1/10» on the info panel - the system works in the «Night» mode.

The minimum and quietest mode of operation of the system, which is designed to work at night.

Activated with the  button on the remote control or the  button in the mobile application.



VENTILATION MODE

«10/10» on the info panel - the system works in the «Ventilation» mode.

The maximum operation mode of the ventilation system. The «Ventilation» mode is activated by the  button on the remote control or the  button in the mobile application.

ADJUSTMENT OF THE INDICATION BRIGHTNESS

In order to ensure the comfort of operation of the system in the dark, we have provided 6 levels of display brightness.

The brightness of the display can be adjusted with the  button on the remote control or  in the mobile application.

DATE AND TIME FUNCTION

For additional comfort of the operation, the date and time function is optionally available in recuperators. The function is activated via an additional menu.



The system (recuperator) receives the date and time from your smartphone during synchronization.



When disconnecting the system from the power supply network, synchronization should be repeated.

If you remain the date or time active, it will be displayed until you switch the information display.

SLEEP TIMER FUNCTION

The function is highlighted on the display panel .

The function is activated by the  button on the remote control or the  button in the mobile application.

The timer configuration is switched by the   buttons on the remote control or +/- in the mobile application.

9 timer configurations are available.

When selecting a configuration, the display panel indicates the time after which the system is automatically turned off.

Timer configurations:

- 10 min • 20 min • 30 min • 1 h • 1 h 30 min • 2 h
- 3 h • 5 h • 9 h

«AUTO» mode is activated by the AUTO button on the remote control or in the mobile application.

«AUTO PLUS» mode is activated by double-pressing the AUTO button on the remote control.

When the «AUTO» indicator on the info panel is green, the «AUTO» mode is on.

There is no separate «AUTO PLUS» mode indicator.

The system informs about the startup process of the mode with the indicator «AUTO» on the info panel, and the display on the info panel with the caption «AUTO +» for only 1 second.

The operation mode works according to a special algorithm that selects the optimal settings based on the data obtained from the sensors * in real time.



In the «AUTO+» mode the recuperator works according to the algorithm similar to the «AUTO» mode, but with restrictions on air exchange to more comfortable noise load.

The maximum allowable speed of fans is 3.

The algorithm responds to increasing relative humidity and/or deterioration of air quality by automatically increasing/decreasing the system performance, depending on the data obtained from the sensors.

* The availability of certain values of sensors and algorithms depends on the configuration of your recuperator.

* In system configurations where there are no air quality sensors (CO₂eq and TVOC), the algorithm takes into account only the value of the relative humidity sensor (Rh).

The «Mini-heating» function is activated by the  button on the remote control or the  button in the mobile application.

When the  indicator on the info panel lights up in red, the «Mini-heating» function is on.

If the «Mini-heating» function is switched on in the «Night» mode, the supply air temperature may increase (up to 3-5°C).

When the temperature outside is below 4°C, in order to prevent the system from freezing and icing of the heat exchanger and condensate outlet, the system must work with the «Mini-heating» and «Winter mode» functions activated.

When the «Winter mode» function is activated, the «Mini-heating» function is automatically activated as well.

Operation in «AUTO» and «AUTO+» mode.



In PRANA ventilation systems of the ERP series, when the auto mode is switched on and the supply air temperature before recuperation is below + 4 °C, the «Mini-heating» and «Winter mode» functions are switched on automatically.

In PRANA ventilation systems of the ERP PRO series with the auto mode switched on and the supply air temperature after recuperation is below + 14 °C, the «Mini-heating» and «Winter mode» functions are switched on automatically.

Based on the indicators of (optional) temperature sensors, the functions «Mini-heating» and «Winter mode» are switched on and off automatically.

The «Winter mode» function is designed to ensure the correct operation of the system in the cold season.

In order to prevent the system from failing and to ensure its correct operation, the use of «Winter mode» accompanied by the function «Mini-heating» is mandatory at ambient temperatures below + 4 °C.

In order to start the system in the cold season, turn on the «Winter mode» function with the  button on the remote control or the  button in the mobile application, and then select the desired mode of operation of the ventilation system.

After the time on the «Winter mode» timer has elapsed (1 min), the ventilation system switches to the selected operation mode.

During the waiting time, «WAIT» appears on the system display.

The engines of the ventilation system are started only after the time on the timer «Winter mode» has elapsed.

After the system is switched off, the «Winter mode» works for another 30 minutes to prevent icing in the system, which may lead to reduced efficiency or complications of condensate drainage.

Operation in «AUTO» and «AUTO+» mode.

When the indicator on the info panel lights up in white, the function is switched on and heating elements are in a passive condition. When the indicator on the info panel

lights up red, the heating elements are in operation.

In PRANA ventilation systems of the ERP PRO series, the heating elements are automatically switched on at the supply air temperature before recuperation below + 4 °C, and they are switched off at + 8 °C. If the outside temperature is higher than + 18 °C, the «Winter mode» function is not available.

In PRANA ventilation systems of the ERP series, the heating elements are automatically switched on at the supply air temperature after recuperation below + 14 °C, and they are automatically switched off at + 20 °C. If the supply air temperature after recuperation is higher than +30 °C, the «Winter mode» function is not available.

The content of the tab is graphically shown below.

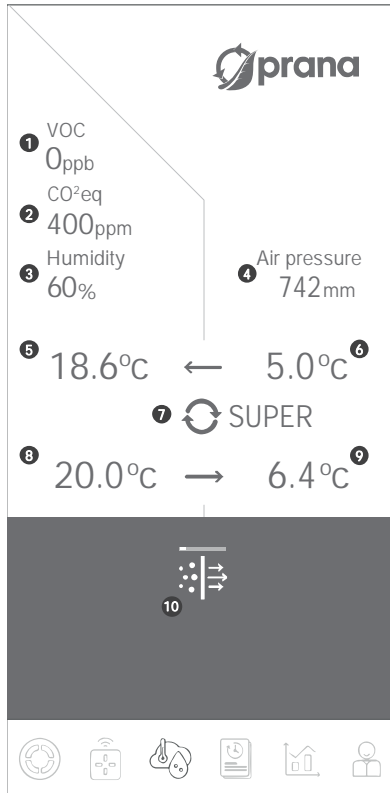

Information from the sensors can be checked in real time.

The availability of certain values from the sensors depends on the configuration of your recuperator.

Correspondence of values «Indicators from sensors».

1 - Air quality indicator, TVOC

2 - Level of carbon dioxide equivalent, CO₂eq

3 - Relative humidity, Rh%

4 - Atmospheric pressure, mm Hg

5 - Supply air after recuperation, °C

6 - Supply air to recuperation, °C

7 - Approximate efficiency

8 - Exhaust air before recuperation, °C

9 - Exhaust air after recuperation, °C

10 - Filter contamination indicator

In addition to real-time viewing, these indicators are used to graph plotting and are displayed in statistics.

Statistics are collected only when connected via an Internet connection and stored in the storage.

If you are interested in connecting via an Internet connection (Wi-Fi module), refer to the «Account» section.

EFFICIENCY INDICATOR FUNCTION

The function is intended for approximate determination of the efficiency indicator, the values of which may depend on the environmental conditions and the operation mode of the system.

The result is shown on the recuperator display in the additional menu or in the mobile application.

The maximum efficiency is reached at the lowest mode of productivity. As the performance mode increases, then the efficiency decreases.

Measurements are made using temperature sensors, which can optionally be located in the system.

- Before recuperation from the room;
- Before recuperation from the street;
- After recuperation towards the room.

When the temperature of the outside and inside of the room has a difference from 0 to 5°C (approximately), the efficiency is not calculated.

For the convenience of determining the efficiency of the PRANA recuperator, we have provided 3 levels of indication:

- SUPER - Efficiency of 80% and above
- HIGH – Efficiency of 60-79%
- GOOD - Efficiency up to 60%

FILTER STATE DETERMINATION FUNCTION





This function approximately determines the contamination rate of the supply air filter for further cleaning or replacement.

The measurement is carried out using an atmospheric pressure sensor, which can be optionally located in the system, the result of which is displayed only in the mobile application.

The filter state is determined at the time of system starting or during automatic (scheduled) inspection by means of the measurement of the filter capability.

FLTCH - This capture on the info panel of the recuperator testifies to automatic (scheduled) check of the filter contamination.

Check the state of the filter periodically, following the marks in the table.

-  No filter
-  The filter is in good condition
-  Clean or replace the filter
-  Error - dirty filter

The content of the tab is graphically shown below.

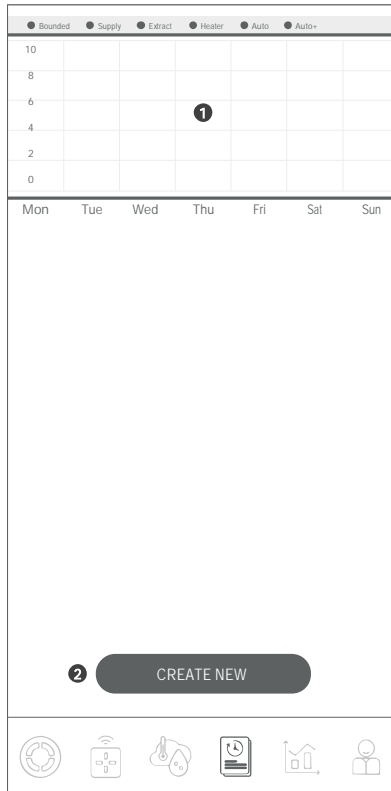

System operation on schedule. Ability to choose operating modes on certain days and intervals.

- 1 - Visual representation of the programmed operation modes.
- 2 - The button allows you to create a new rule for scheduling.

PROGRAMMABLE CONTROL FUNCTION

The function allows you to pre-program the operation mode of the recuperator at certain intervals.

In order to create a new rule, click «Create new».

In the «Start» field, select the day of the week and the start time of the event. If you want the event to be repeated every day, select «Everyday».

In the «Finish» field, select the day of the week when the event ends.

If you select «Everyday» in the «Start» item, the event will end every day.

After entering the time frame, select the function or mode in which the system (recuperator) should operate during this time.

A description of the available functions and modes is shown in the manual.

After the rule ends, the system (recuperator) will return to the previous mode.



If you want to delete a rule, click  to the desired rule and select «Delete».

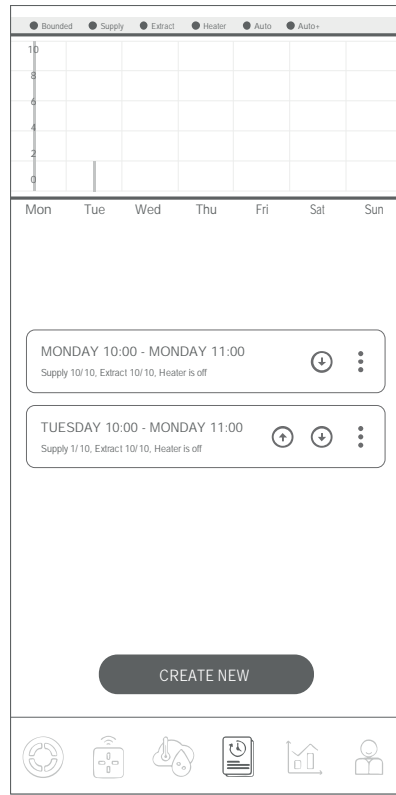
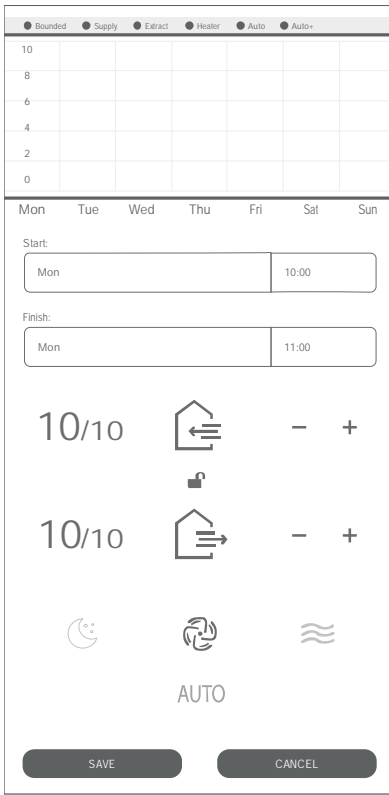

If you want to change the rule, click  to the desired rule and select «Edit». Then make changes and select «SAVE» in order to save.



If you create multiple rules, the one above will be executed first.

After creating the rules, the priority can be set using the navigation buttons:  

By raising more important rules and lowering less important ones, you can adjust different combinations of their interaction.

The content of the tab is graphically shown below.

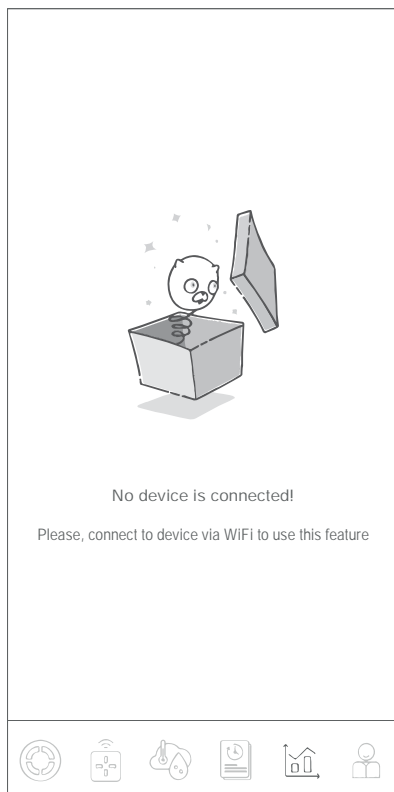

Ability to view indicators from system sensors at different times.

Statistics are displayed and stored only when connected via the Internet (Wi-Fi module in the system). Details are described in the «Account» section.

The content of the tab is graphically shown below.

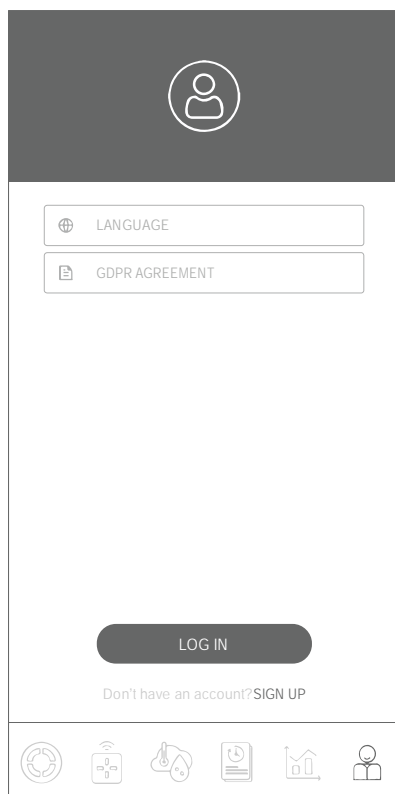

This tab allows you to register and/or authorize in the «PRANA ONLINE» service.

The tab also allows you to read the «GDPR AGREEMENT» policy and select the interface language.

In some PRANA ventilation systems, in addition to the Bluetooth control method, there is a control method via an Internet connection (the system can be equipped with a Wi-Fi module).

In the system configuration section, you can view the presence of this module in your model.

This quick guide describes how to connect using Bluetooth.

Registration and authorization is required only in the case of collecting statistics for future viewing and control by the means of the Internet service «PRANA ONLINE».

The standard set of functions will work without the use of the PRANA ONLINE service, via Bluetooth or the Remote Control, while the statistics from the recuperator are not transferred to the storage.

Systems connected to the account have the ability to update the software automatically.

With updates:

- We correct mistakes
- We expand and improve functionality
- We optimize memory usage, which allows the system to work faster and more efficiently.

If you are interested in connecting via Wi-Fi, refer to the complete user guide.

In order to download the manual, visit the website (prana.help/b22) and select your model and version of the recuperator.

To connect via the Internet connection in any case requires:

- Go through the initial Bluetooth connection
- Your room must have a Wi-Fi access point (2.4 GHz), with Internet access
- Access to router settings

(In some cases, the connection to the server may be blocked by the firewall, depending on your network equipment or network operator).

REMOTE CONTROL FAILURE

If you experience a failure of the remote control during operation, follow the instructions in this manual.

The images show the back of the remote control.

- Press lightly on the ribbed part of the back cover.

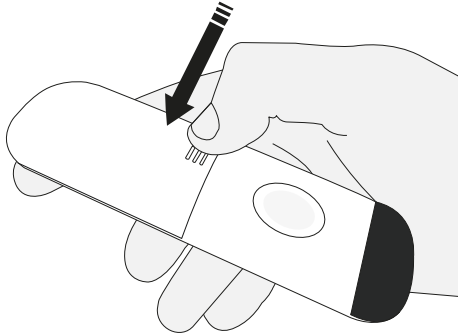

- Slide the cover out of the remote control.

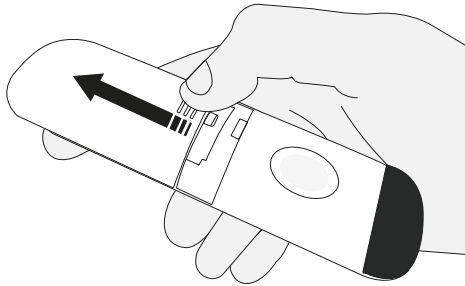

- Rotate the batteries around their axis (as shown in the illustration) and check for visible trace impurities.

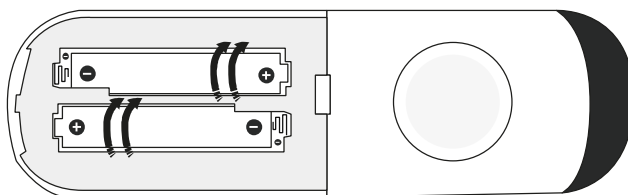

The type of batteries used in the remote control is AAA/R03/1.5V.

- If the batteries are missing, proceed to install the batteries (installation and removal of the batteries is described in «Batteries replacement of the Remote Control»).
- If the remote control does not work after rolling the batteries (or the batteries are visually contaminated), go to «Cleaning the remote control contacts».
- If there is no visual contamination, but the batteries do not work, go to «Batteries replacement of the Remote Control».

BATTERIES REPLACEMENT OF THE RC

- Remove used batteries from the remote control.

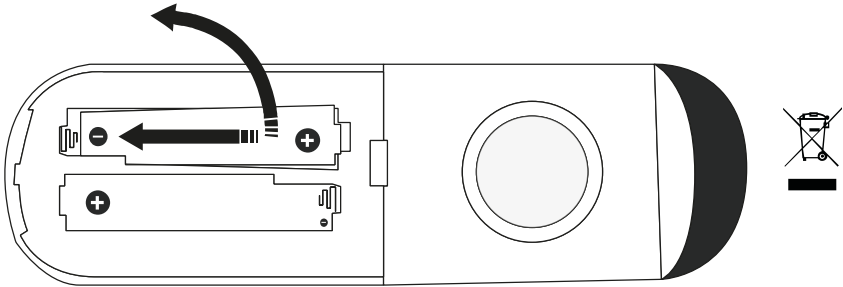

- Install new batteries in the remote control carefully following the polarity of the «+» and «-» connections indicated in the compartment.

Insert the batteries starting from the «-» side.

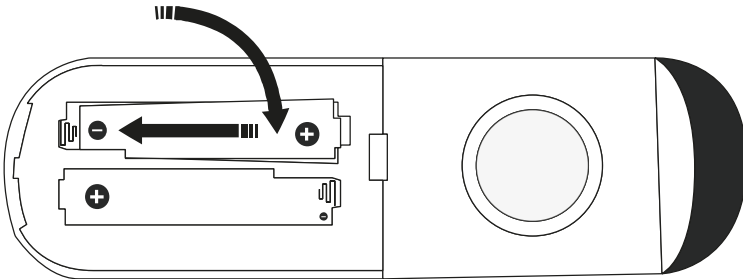

- Place the back cover on the remote control, push it all the way in and make sure the cover is in the home position.

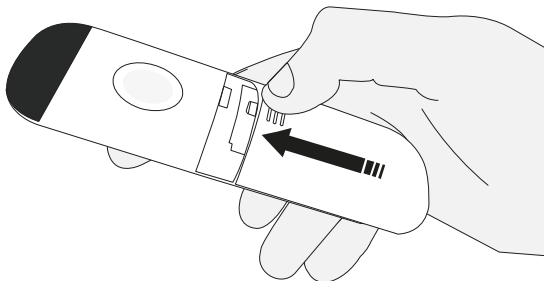

CLEANING THE REMOTE CONTROL CONTACTS

Clean the contacts of the remote control with a small amount of special cleaning agent (for example, KONTAKT 60) using a cotton swab, a cotton stick or a soft cloth.

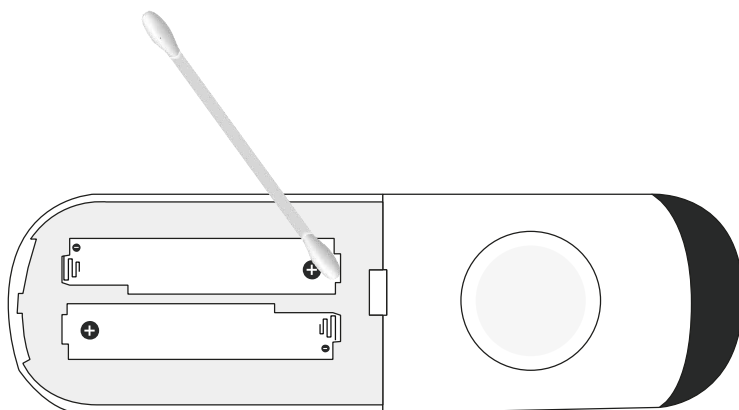

If the remote control no longer works after all operations (cleaning the remote control contacts and batteries replacement of the remote control), contact the service center of the manufacturer or dealer in your area.

Dealer contacts can be specified in the warranty card (warranty card is in the product technical passport).

Difficulties in using of the ventilation system and troubleshooting methods:

If you have a situation not described in this section of the instructions, contact the service center of the manufacturer or dealer in your area.

Dealer contacts can be specified in the warranty card (warranty card is in the product technical passport).

• EFFICIENCY REDUCTIONS •

- Insufficiently sealed space between the mounting hole and the outer housing of the recuperator.

TROUBLESHOOTING METHOD: Reassemble using sealing materials.

- A considerable part of the system protrudes from the wall.

TROUBLESHOOTING METHOD: Use insulation.

- Lack of recommended periodic service.

TROUBLESHOOTING METHOD: Carry out service.

• COLD SUPPLY AIR •

- Influence of mechanical and natural ventilation systems.

TROUBLESHOOTING METHOD: Regulation of air flow by means of ventilating grilles. Stopping local ventilation or reducing its productivity.

- Front venting of system.

TROUBLESHOOTING METHOD: Installation of an external wind-proof cover.

• CONDENSATE FLOW INTO THE PREMISES •

- Incorrect angle of the mounting hole.

TROUBLESHOOTING METHOD: Carry out the correct installation.

- Lack of recommended periodic service.

TROUBLESHOOTING METHOD: Carry out service.

- Radial displacement of the system in the housing

TROUBLESHOOTING METHOD: Carry out the correct mounting.

• ICING OF THE SYSTEM •

- Ignoring the function «Mini-heating» and «Winter mode» at ambient temperatures below +4°C.

TROUBLESHOOTING METHOD: Use the «Defrost» function, carefully follow the operating instructions.

• THE SYSTEM DOES NOT START •

- No voltage in the network.

TROUBLESHOOTING METHOD: Check for network voltage.

- Power supply is not connected.

TROUBLESHOOTING METHOD: Make sure the power supply is properly connected to the ventilation system.

SYSTEM MAINTENANCE

Maintenance of the PRANA ventilation system involves periodic (recommended at least 1-2 times a year), preventive inspection and cleaning of fan surfaces and heat exchanger surfaces.

Procedure for disassembly/assembly of the device for/ after cleaning:

- Press the «Turn off» button on the remote control or in the mobile application.

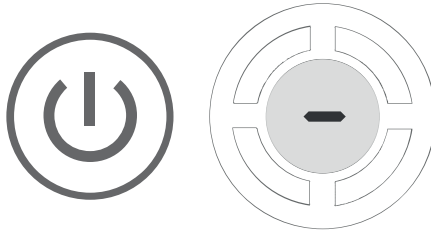

- De-energize the ventilation system.

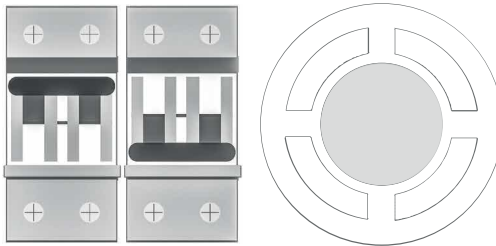

- Open the front cover of the recuperator.

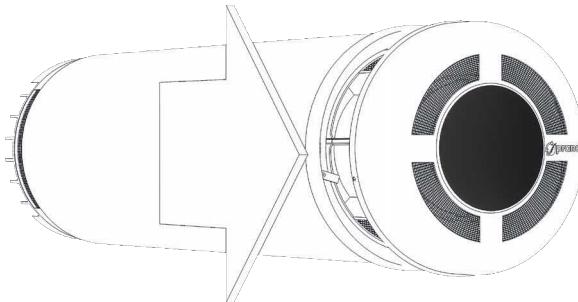

- Turn the fixing lock of the cover and remove.

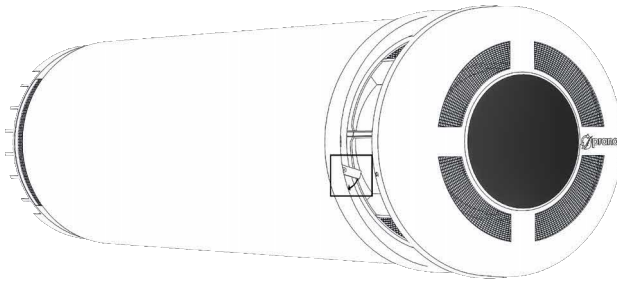

- Disconnect the cable and remove the power cords by pressing the terminals. Release the cover.

- Twist the screws from the flange. Remove the flange.

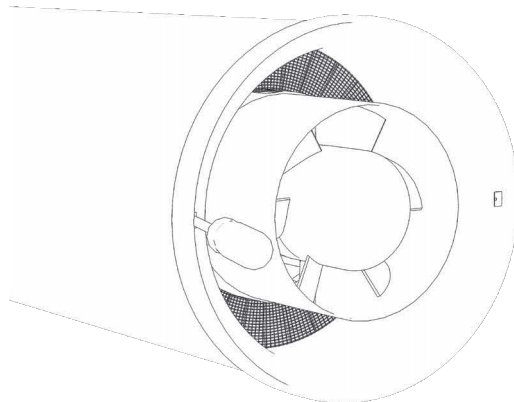

- Remove the heat exchanger and fans from the housing.

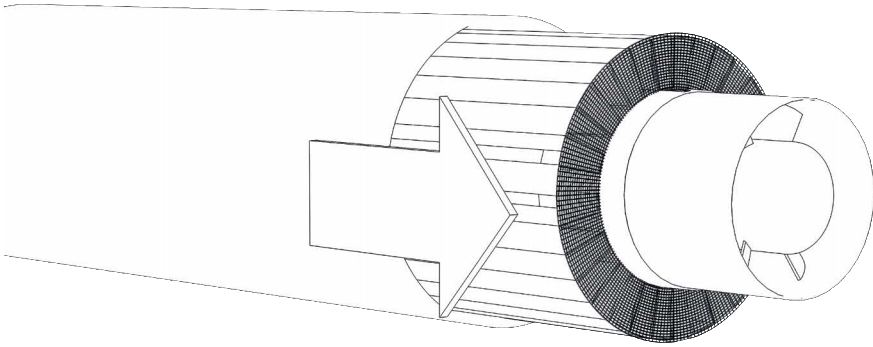

- Twist the screws. Remove the fans on both sides.

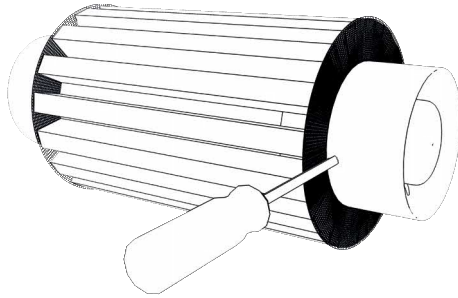

- Clean the heat exchanger by dry method.

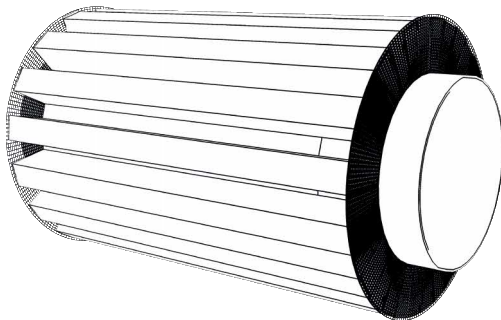

- After cleaning, collect in reverse order.
- The heating of the condensate drain (heating element) must be at the bottom near the hole on the housing.

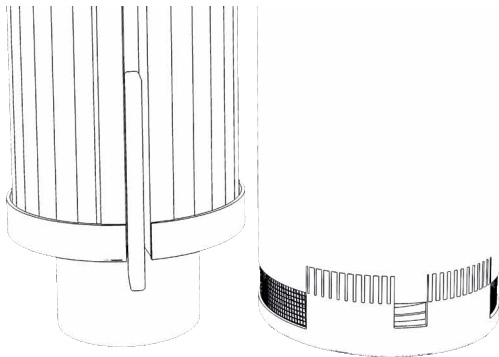

- The flange must be installed correctly; the larger protrusion of the board must be at the bottom.

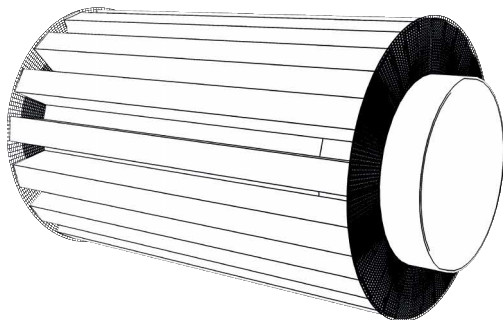



MODEL RANGE: PRANA 2022[®]